



PRO-SOUND CEILING LOUDSPEAKER

CCS4

This low-impedance bassreflex ceiling mount loudspeaker consists of a low-frequency chassis and an additional high-frequency driver. The closed back allows for a bass reflex construction, which is reflected in the excellent reproduction of music. Atypical for 100V speakers is the extremely high sound reproduction and the balanced sound picture, which impresses with the first hearing. Wherever powerful basses and clear heights are required to create the right atmosphere, this speaker is the first choice. The performance can be adjusted without great effort with a selector switch below the front grille.



● Electrical	
Rated power, watts	30
Tappings 100 volt line, watts	30/15/7.5/3.75
Transformer Impedance, ohms 100V	330/660/1.32k/2.64k
Tappings 70.7 volt line, watts	15/7.5/3.75/1.875
Driver impedance, ohms	16
Effective Frequency Range, Hz (BSEN60268-5)	65-19.500
S.P.L. @ 1m, 1watt, dB, test signal bandwidth 100Hz - 10kHz	86
S.P.L. Full power, octave bandwidth, dB	101
Acoustic power (dB-PWL @ 1 watt) 1k/2k Hz, dB	86/88
Dispersion at 1k/2k Hz, Degrees	180/160
Directivity axial Q factor, 1k/2k Hz	2.40/4.5
● Environmental	
IP-rating	n/a
Min/Max amb temp	-10°C to 55°C
Relative humidity	≤65%
● Mechanical	
Dimensions, front and depth, mm	195.50x206.74
Net weight, kg	2.2
Colour/Finish	White
Material	Plastic Baffle ABS with UV Inhibitors
Cut-out, mm	Ø168
Mounting	Rotary Compression Clamp. Mounting Baffle available on request



ATEIS Europe B.V.
 Celsiusstraat 1, 2652 XN Lansingerland, Netherlands
 Phone +31 (0)10 208 86 90, www.ateis-europe.com, info@ateis-europe.com





PENTON

INSTALLATION GUIDE

CCS4

Side view
(unit: mm)

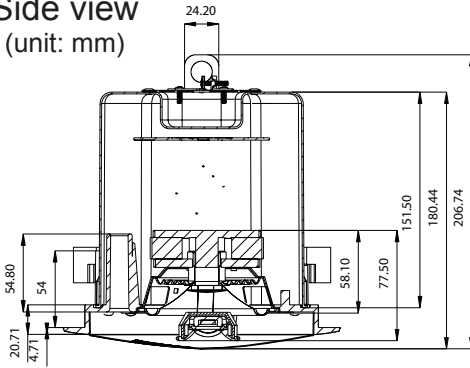

Side view
(unit: mm)

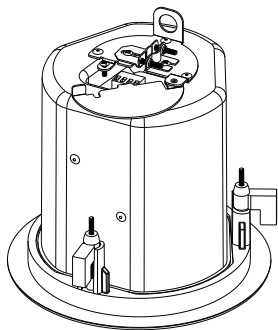
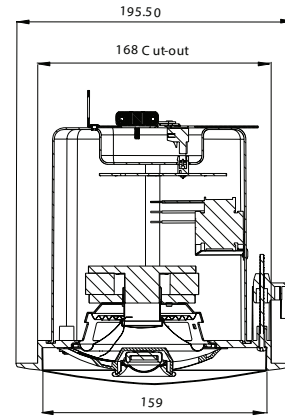

Side View

Compression
Clamp.
Push Down

1) Cut a hole in the ceiling 168mm diameter

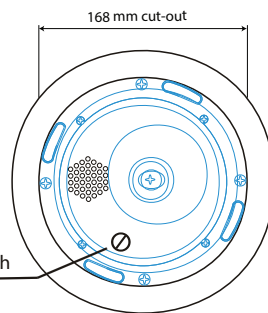

Front View with grille removed

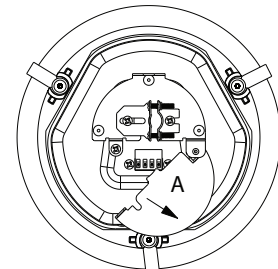

Top View

2) Remove the metal grille from the front of the loudspeaker by pushing all the rotary compression clamps down towards the grille

3) Once the grille has been removed connect the 100 volt line input cable via the terminal block secured under the rotating cover shown below "A". To select the required wattage output use the tapping selector switch shown in the above drawing. This unit is also available in low impedance (16 ohms) Model CCS4 and will be connected as above (the unit will be manufactured minus the 100 volt line transformer)

4) The loudspeaker is ready to be pushed up into the cutout prepared earlier. Ensure that all compression clamps are fully extended to allow for the ceiling thickness. Once the loudspeaker is in position use a cross headed screwdriver and turning it in a clockwise motion you will observe that the clamps will pull down and lock the loudspeaker into position.

5) On mounting the speaker replace the snap fit grille.

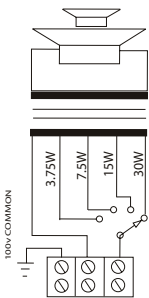

Circuit Diagram

Speech octave band sensitivity

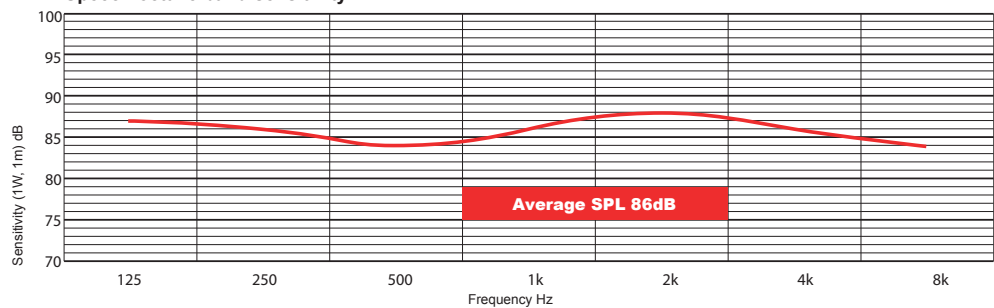

Effective Frequency Range

Disclaimer: We reserve the right of changes and errors.



ATEIS Europe B.V.
Celsiusstraat 1, 2652 XN Lansingerland, Netherlands
Phone +31 (0)10 208 86 90, www.ateis-europe.com, info@ateis-europe.com

