

SENTRY6ST/ENC



The SENTRY6ST/EN is a square, anti-vandal protected metal housing speaker, made of high-quality plastic coated quality steel. It contains a special chassis covering a wider frequency range, making it ideal for both good voice and high quality music reproduction. The robust and aesthetic SENTRY6ST/EN can work on both fixed ceilings as well as on walls supplied with two pre-punched shots for cable glands. It offers the installer the opportunity of looping through and can thus save time and costs during assembly.



EN54-24:2008
0905-CPR-201106
TYPE A

| | |
|---|---|
| ● Standard | Compliant to EN54-24 Compliant to BS5839:8 |
| ● Electrical | |
| Rated power, Watts | 6 |
| Tappings 100 Volt line, Watts | 6/3/1.5/0.75/0.25 |
| Transformer Impedance, Ohms 100 Volt | 1.67k/3.33k/6.66k/13.3k/40k |
| Tappings 70.7 Volt line, Watts | 3/1.5/0.75/0.375/0.125 |
| Driver impedance, Ohms | 8 |
| Effective Frequency Range, Hz (BSEN60268-5) | 110 - 18,000 |
| S.P.L. @ 1 m, 1 Watt, dB, Octave, 100 Hz-10 kHz | 95 |
| S.P.L. @ 1 m, Full power, dB, Octave, 100 Hz-10 kHz | 103 |
| S.P.L. @ 4 m, 1 Watt, dB, 1/3 Octave, 100 Hz-10 kHz | 80 |
| S.P.L. @ 4 m, Full power, dB, 1/3 Octave, 100 Hz-10 kHz | 86 |
| Dispersion at 1k/2k Hz, Degrees | 81/101 Horizontal 108/108 Vertical |
| ● Environmental | |
| IP Rating | 52 |
| Min/Max amb temp | -10°C à 55°C |
| Relative Humidity | ≤95% |
| ● Mechanical | |
| Dimensions, WxHxD mm | 190 x 190 x 75 |
| Net weight, kg | 1.8 |
| Colour (Unless Specified) | White, RAL9016 |
| Material | Steel front, die cast back box |
| Mounting | Screws |
| Safety | Ceramic Block Thermal Fuse Capacitor for DC line monitoring |





PENTON

INSTALLATION GUIDE

SENTRY6ST/ENC

EN54-24:2008
0905-CPR-201106
TYPE A

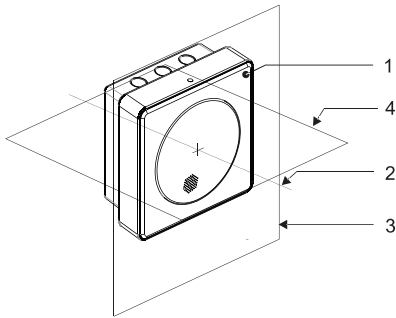
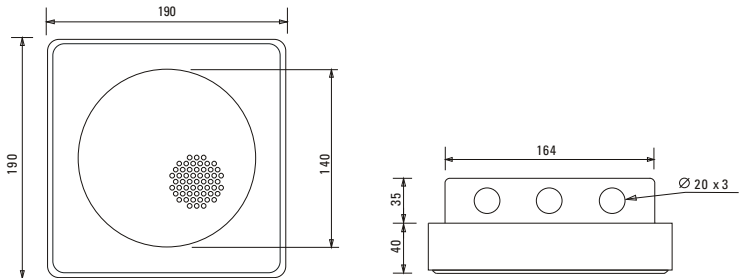

1. Loudspeaker enclosure
2. Reference axis
3. Reference plane
4. Horizontal plane

**With Transformer:
100V/70V line**

| | White wire plus tapping | | | | | | Black |
|---------|-------------------------|--------|-------|-------|-------|-----|-------|
| 100V | 0.25W | 0.75W | 1.5W | 3W | 6W | COM | |
| 70V | 0.125W | 0.375W | 0.75W | 1.5W | 3W | COM | |
| IMP (Ω) | 39.9K | 13.3K | 6.66K | 3.33K | 1.67K | | |

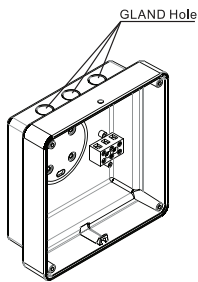

1) Decide on the back box orientation. Normally the back box is installed with the 3 x 20mm knockouts facing upwards. However the back box can be installed in any orientation as well as horizontally on a ceiling if required.

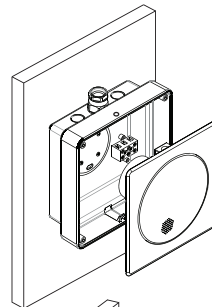

4) Once the back box has been fixed securely to the surface the installation cable can be fitted as required. The cable can then be terminated into the terminal block fitted to the back box. The terminals are suitable to take "loop in"/"loop out" connections up to 2.5mm per core.

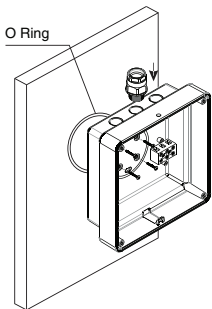

2) The back box has the option of glanding cable directly into any of the 3 x 20mm knockouts or through the rear of the cabinet.

3) Secure the back box to a flat surface using the fixing holes provided. (Fixings are not included). Do not forget to fit the rubber "O" ring between the wall and back box before fixing to the wall. This will ensure that the screw fixings and any rear cable entry will be sealed from water ingress.

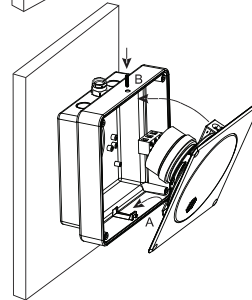

5) Take the speaker plate and connect the 3 pre-installed wires from the terminal block on the back box to the spade terminals provided on the speaker transformer.

6) Slot the speaker plate on to the retaining lug "A" and then push the speaker into the back box. Tighten the grub screw "B" until it firmly hold the speaker plate. Be careful not to over tighten the grub screw.

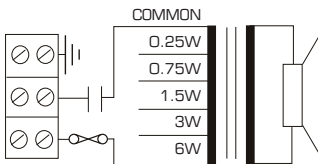

Circuit Diagram

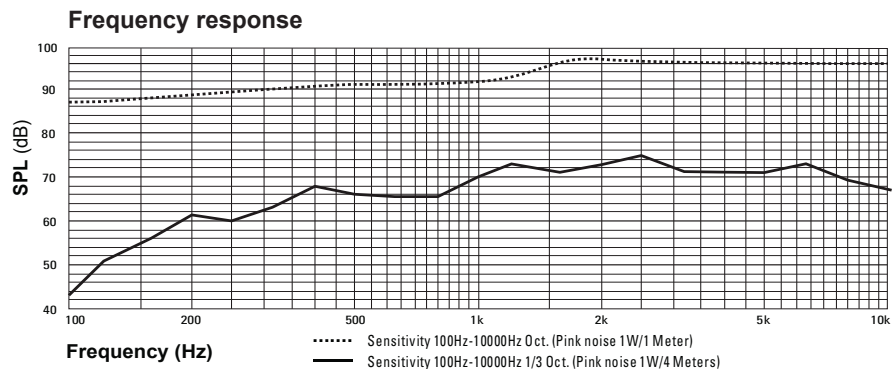

Disclaimer: We reserve the right of changes and errors.



ATEIS Europe B.V.
Celsiusstraat 1, 2652 XN Lansingerland, Netherlands
Phone +31 (0)10 208 86 90, www.ateis-europe.com, info@ateis-europe.com

